

# Optimization-Tool for local renewable energy usage in the connected system: “Building-eMobility”

Dipl.-Ing. Torsten Schwan  
Prof. Dr.-Ing. Bernard Bäker  
Dresden University of Technology  
Institute of Automotive Technologies Dresden  
George-Bähr-Str. 1c, 01062 Dresden  
schwan@iad.tu-dresden.de

Dipl.-Ing. René Unger  
Dr.-Ing. Beate Mikoleit  
EA EnergieArchitektur GmbH

Königsstr. 2, 01097 Dresden  
rene.unger@ea-gmbh.de

Dipl.-Ing. Christian Kehrer  
ITI GmbH  
Webergasse 1, 01067 Dresden  
Kehrer@iti.de

## Abstract

Renewable energy production and decentralized energy storage as well as optimized usage of existing energy resources are matters of rapidly growing importance. Even today in building architecture as well as modern mobility concepts these technologies are major cost drivers.

Staying abreast to these changes, EA EnergieArchitektur GmbH together with IAD TU Dresden are developing a simulation tool to identify and optimize the potentials for building specific energy storage and production as well as optimized usage strategies on the consumer side.

Furthermore the simulation tool allows analyzing the smart integration of new eMobility concepts. In this it works as a test bench for system wide energy management with priority on charging strategies for such vehicles from the decentralized power supply.

*Keywords: renewable energy; eMobility; modeling*

## 1 Why a holistic energy simulation for car and building

Today, there are various technologies available to provide local renewable energy, for example: micro-wind-turbines, photovoltaics, solar heat, heat pumps and combined heat and power units (CHP).

These energy systems use direct natural energy resources like wind and sun or renewable fuels like wood, bio-gas or even vegetable oil. The availability and efficiency of these resources differ greatly depending on the specific location. Furthermore these energy systems are expensive in money and production resources. Therefore it is important to find an optimized configuration before installing an energy system in a specific building.

A second thought on optimizing renewable energy includes the time of availability. There is no sunshine at night. Is it better to store the daylight energy using batteries, charge a heat storage or to install the photovoltaics facing westwards thus providing more energy when demand is high - in the evening?

In the course of the increasing demand on electric mobility, the need for charging concepts has risen. Both power and energy have to be provided. Synchronization of the demand on energy and storage as well as on availability in a building is an important fact for future energy-management systems.

Electric Mobility as mobile storage with constraints to availability (docked, undocked) and requirements from lifestyle (e.g. 100% charge in the morning) adds further complexity to the system.

The energy system layout for a specific combination Building-eMobility as well as the research and development of optimized energy-management algorithms are two engineering tasks which demand for a

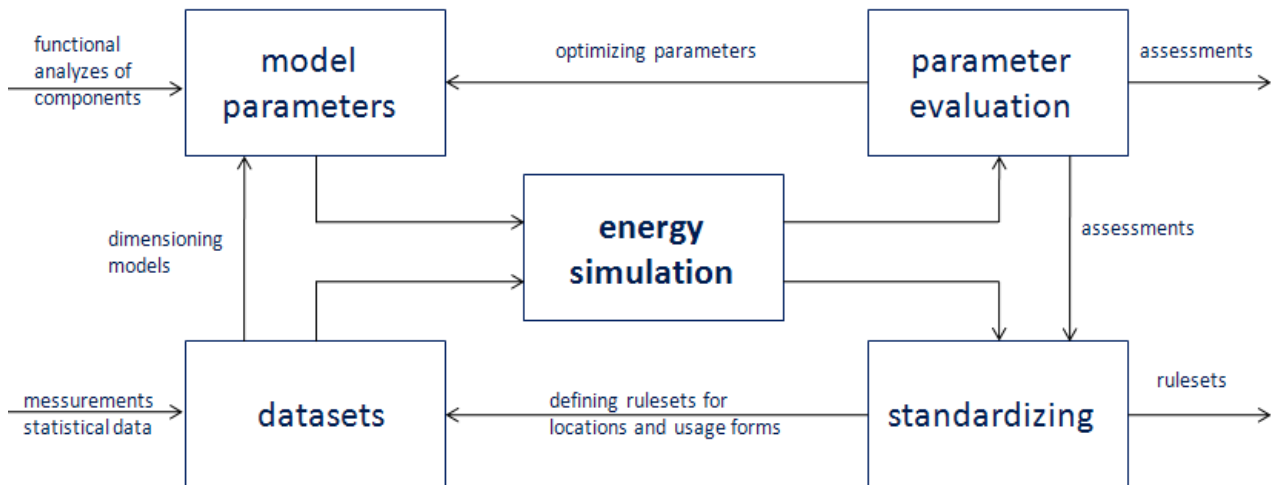

Fig. 1: Structure of the energy simulation process

dynamic simulation covering all macroscopic aspects of the system.

Such a simulation system is not available, yet. Existing Software either covers only one of the subsystems (e.g. PVSol) or it does not include costs and dynamics using precalculated balances instead.

This paper shows a different approach using the interdisciplinary modeling Language Modelica to implement physics and information flow as well as cost-specific behavior of building-related renewable energy systems in the same set of differential and algebraic equations. Additionally the object oriented modeling concept allows to describe well-arranged and understandably system behavior of the power generation, storage and consumption components.

The tool under development presented in this paper is able to simulate and evaluate the energy flow in the holistic connected system “Building-eMobility”. It will be used to layout the most energy and cost efficient combination of components as well as for testing intelligent energy-management algorithms in much-faster-than-real-time (accelerated SiL).

Since the main focus is on system layout and benchmarking the location specific energy and cost efficiency, the applicable level of detail is an important fact on model design.

## 2 Concept of the energy simulation model

The basic conceptual design requirements of the simulation model can be deduced from the desired simulation results.

The development of precise rules for the renewable energy system layout, depending on local climate and planned usage, requires a reduced set of possible subsystems for the later system composition (i.e. micro-wind-turbines, electric car, electric bike, etc.).

Additionally a common set of input-parameters based on availability (i.e. weather statics) and building design (heat-transmission, inhabitants) needs to be defined.

The analysis of a specific location over long time periods (>1 year, <1 minute step) with regard to different system layouts, cost, availability and energy independence requires easily replaceable subcomponents (i.e. Photovoltaics / Solar Heat) with integrated cost functions as well as the use of “real-world” measurements as input-data.

To enable parameter variation the calculation needs to be fast, thus phenomenological descriptions instead of real physics should be used wherever possible.

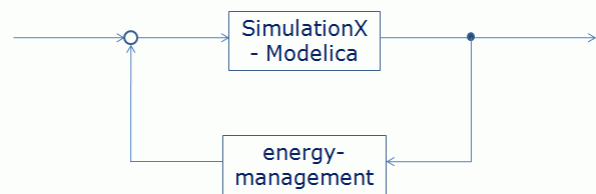

Fig. 2: SiL-application of the simulation environment including energy-management-algorithms

The finished simulation system will act as a test bench for advanced energy management algorithms. Therefore the integration effort for a simulated or SiL-energy-manager needs to be reasonable. In these

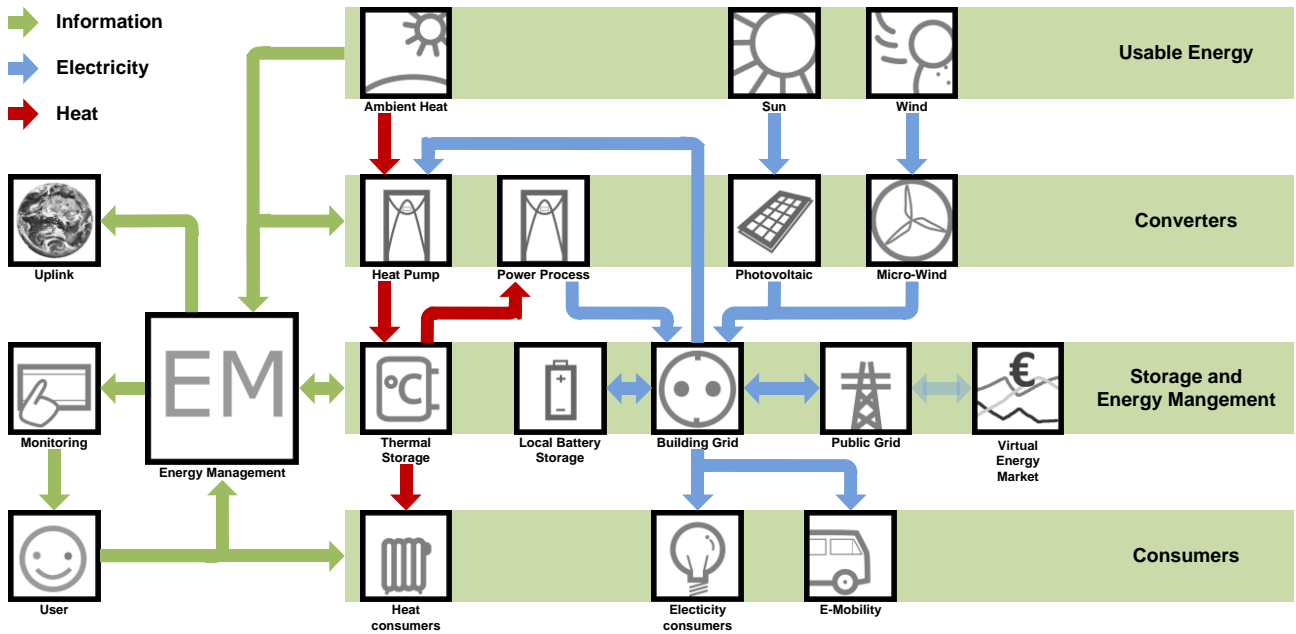

Fig. 3: Energy and information flow in a specific scenario building - vehicle

tests critical system states (e.g. power shortage, empty car battery in the morning) should be detected automatically and calculated in higher time resolution. Fig. 1 shows the basic simulation process.

The SiL-energy-manager could be implemented as an algebraic equation system including all relevant measurement and control signals. An integration of an outstanding control-block as energy-manager implemented in another environment like Matlab/Simulink is also imaginary.

The resulting simulation consists of a library of subsystem-models for each specified component. These sub-models are connected using an energy-bus and a cost-function-bus. Especially interesting components like micro-wind-turbines and batteries are available as fast phenomenological models as well as exact physical models. Besides the energy-components, different models for inhabitants, climate and utility company were created.

### 3 Examples for Subsystem-Models

In this paragraph an abstract of the implemented Subsystem-Models used in the energy simulation tool is described. Special attention is turned on the model requirements dealing with the discrepancy between fast system calculation time and precise simulation results. For implementation partially existing approaches were used.

#### 3.1 Micro-Wind-Turbine

The Micro-Wind-Turbine model calculates the electrical energy output of a building integrated wind power plant. Input-data is wind speed and direction for a specific location, based on “real-world” measurements or statistics. With attention to all existing physical relations like angle of incidence, acceptable operating range and aerodynamic configuration of the turbine, the wind power absorbed by the turbine during the integration time step is calculated.

Depending on the specification of the gearing mechanism and the designated type of electric generator, i.e. asynchronous machine, the model simulates the generated electrical power from the turbine power.

To improve calculation time and to avoid problems with the internal logic of modern smart inverters the phenomenological behavior is replicated. Therefore the model is based on generator specific characteristic curves (e.g. dependency of open-circuit-voltage and generator torque on generator velocity) in a closed loop control with turbine power as reference instead of magnetic coupling and switching diodes.

The behavior of the net-coupling inverter is rendered in a similar way with additional inputs for external power management.

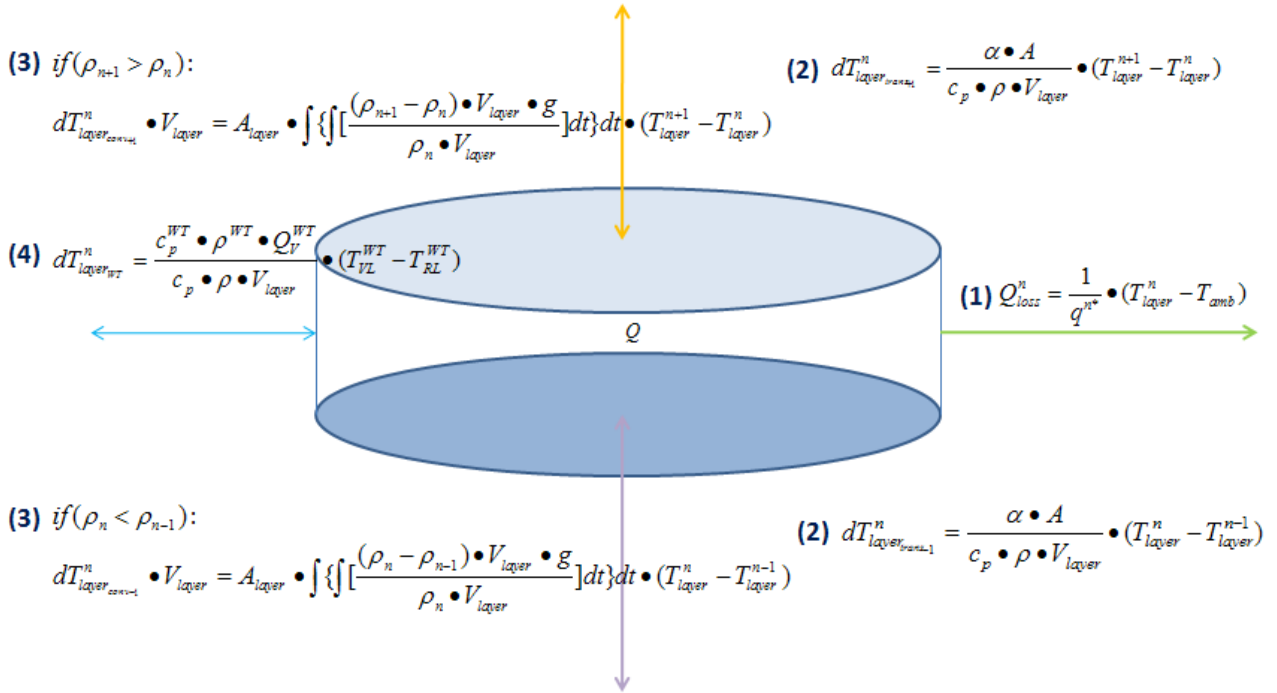

Fig. 4: Differential equations describing the behavior of the heat storage tank

### 3.2 Heat Storage

The Heat Storage model describes mathematically the behavior of the temperature spreading in a tank which is used to save thermal energy. The model considers the energy losses of the tank through the isolation (1) and the heat transfer (2) as well as the heat convection (3) between the different temperature layers in the tank. The describing differential equations for one layer are shown in fig. 2. Also the heat dissipation and supply of a layer (e.g. by heater or Heat Pump) is implemented in the model (4).

The model will be parameterized by the physical dimensions of the tank and the integrated heat exchanger. Another describing parameter set consists of the thermal characteristics of thermal storage media. Output of the simulation model is the amount of energy put in or dissipated from the Heat Storage and the temperature spreading in the tank.

Although there have been existing a lot of different models for Heat Storage systems the presented model have become necessary because these models were so detailed that the simulation time would have been very long. So the presented model was adapted that way that only the behavior of the temperature spreading in the Heat Storage will be contemplated.

### 3.3 Battery

Electrical Batteries are a major field of research at the IAD TU Dresden. Based on these long-term studies, Batteries are described mathematically to render the exact electrical behavior of a black-box at its terminals. The fast model defines a number of battery strings, each consisting of a specified number of in series connected battery cells.

These cells are parameterized by measured characteristics (e.g. impedance, open-circuit-voltage) of different types of battery cells (e.g. Li-Ion). Out of these characteristics the model calculates the realizable power supply of the battery depending on the state of charge and other characteristic battery conditions (e.g. cell temperature).

This battery model allows simulating the power supply of different types and dimensions of batteries within a very short simulation time because inner chemical processes were neglected. Additionally it enables the calculation of the specific lifecycle-cost including usage dependent cell aging.

### 3.4 Heat Pump

A heat pump is a machine to transform heat from a reservoir with lower temperature (e.g. ambience) to a higher temperature level for heating and storage. The focus is put on electrically driven pumps.

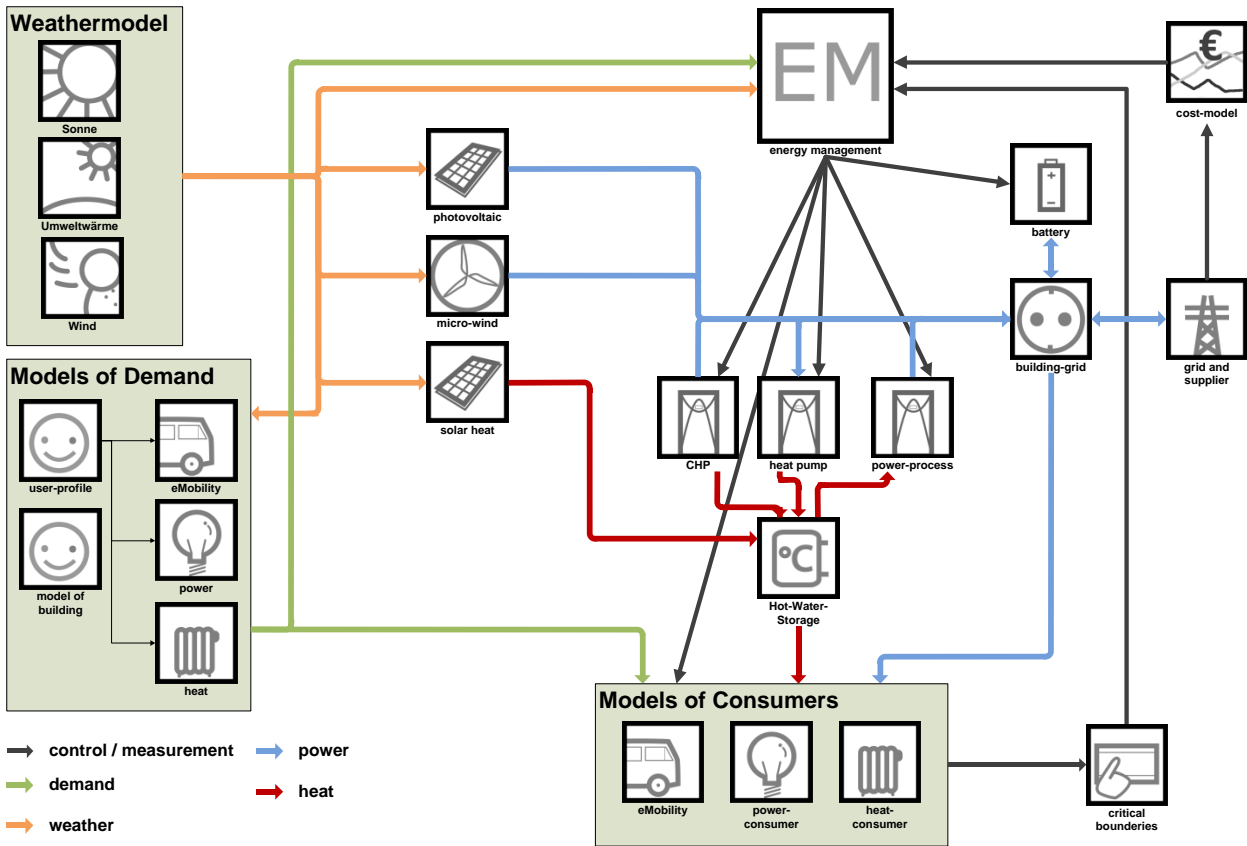

Fig. 5: Simulation concept and subsystem models for weather, demand, resulting consumers and energy generation, storage and management subsystems

In the process the working medium (e.g. CO<sub>2</sub>, R407C) is subjected to a thermodynamic cycle. Although it is possible to implement this thermodynamic cycle in a mathematical model, the model level of detail for exact representation would be far too complex for the short simulation time requirement. Therefore another approach was chosen for modeling this system comparable to other subsystem-models.

The method used for modeling the Heat Pump divides two phases for the calculation of the supplied heat of a Heat Pump, the dissipated heat flow between the working medium and the heating medium and the rise of the enthalpy of the heating medium per time unit. These two heating flows are equal in steady states. So for the simulation of the heating flow of characterized Heat Pumps the model uses manufacturer data for the input-data-related steady state heat and electrical power flow.

The dynamic of the heat pump respective input-data and heat flow modification as well as switching operations necessitates other modeling methods. The problem is solved on the one hand by model partitioning between heat dissipation and generation.

On the other hand the different types of switching operations (normal switching, de-icing) are modeled

as loop controller with different time constants.

Fig. 6 shows the model structure used to calculate the switching transient behavior of a Heat Pump after a de-icing process because of coincidental switching of ventilator, circulating pump and heat pump. Also simulation results for behavior of heat power at normal switching events compared with after-de-icing events are presented.

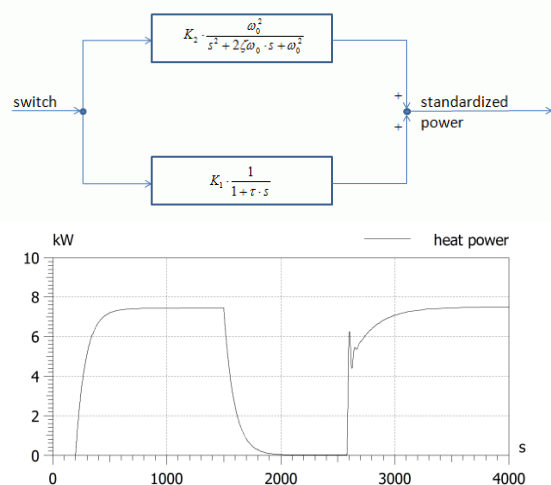

Fig. 6: Model of switching transient characteristic after de-icing (above), simulation results (below)



Fig. 7: Simulation library pictured as mind map



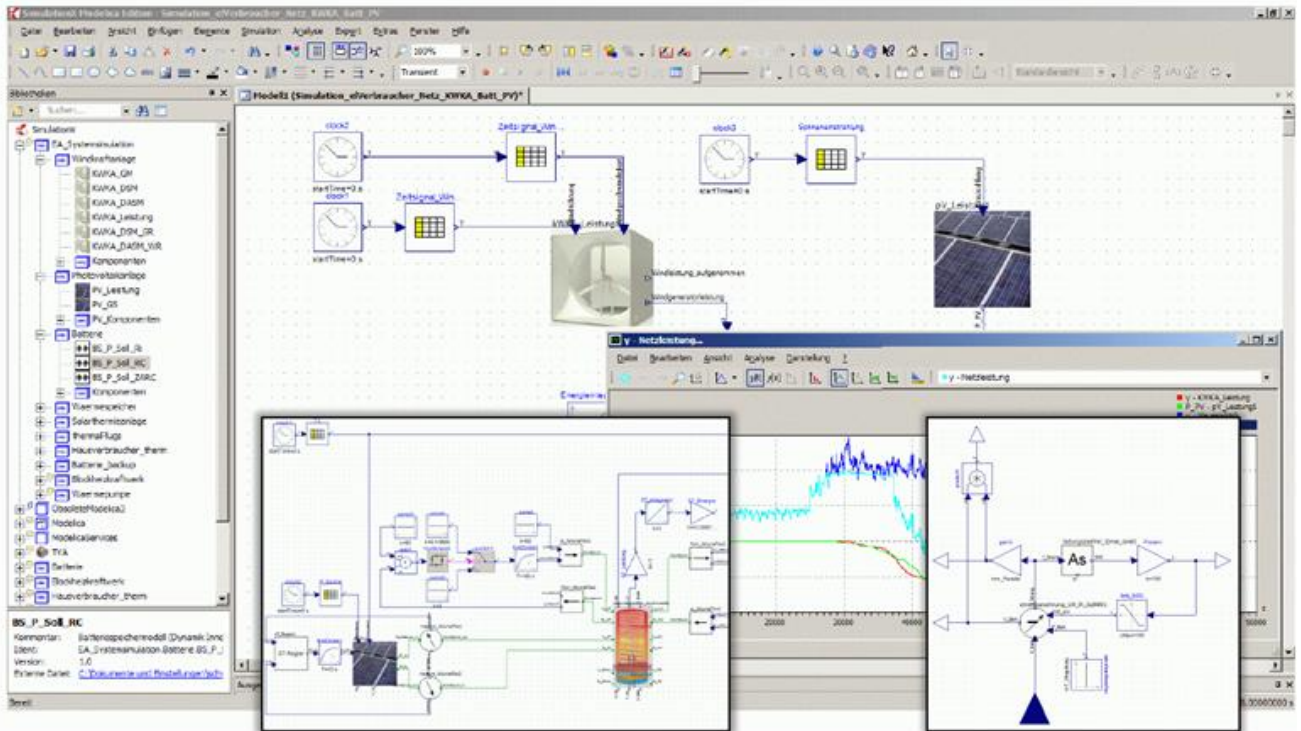

Fig. 8: Screenshot of the simulation model including the used libraries

## 4 Gathering Input-Data

Simulation results are only as good as the input-data they are based on. Therefore the important groups of data like weather and climate, technical characteristics of components and energy statistics have to be gathered for specified simulation scenarios.

Weather and climate are important for the energy output as well as the demand. Statistics for local climate are available from various sources like “Deutscher Wetterdienst” but these are often cost intensive. To analyze weather dynamics we use long term measurements (i.e. wind speed) with high time resolution (1s) at the specific location. Since these datasets are too huge for reasonable use within SimulationX, extensive preprocessing is done. The resulting parameters are used in a weather sub-model to create stochastic signals with characteristics similar to the original measurement.

The technical characteristics mostly depend on the datasheets of the used components. Special emphasize is put on the characteristics of micro-wind-turbines (a primary technology of EA GmbH) and battery storage (IAD).

Energy-data is generated similar to weather data based on energy-suppliers statistics, market-data and direct measurements at our research sites. The result-

ing weather, market and usage model can provide stochastic output signals based on season and time of day.

## 5 Synthesis of a holistic model

Based on the simulation scenario the holistic model consists of the corresponding parameterized submodels for the energy system components (i.e. 10m<sup>2</sup> PV, heat-pump, 5 kWh battery, 2 cars, etc.). Respectively the models for users, environment / weather, consumption and provider are added and configured. The according “real-world” input-data for the scenario is stored in external files and fetched at simulation time.

To simplify the simulation model and to improve the clearness, signals like velocity and direction of wind, are unified to bus systems. The main busses connecting the subsystem-models are energy-bus, cost-bus, environment-bus and energy-management-bus. Due to the calculation time requirement, most connections are signal couplings (only variable information) as opposed to physical coupling (real physical variables).

These couplings are divided into special-defined connectors for thermal and electrical elements. Therefore these connectors allow the connection of

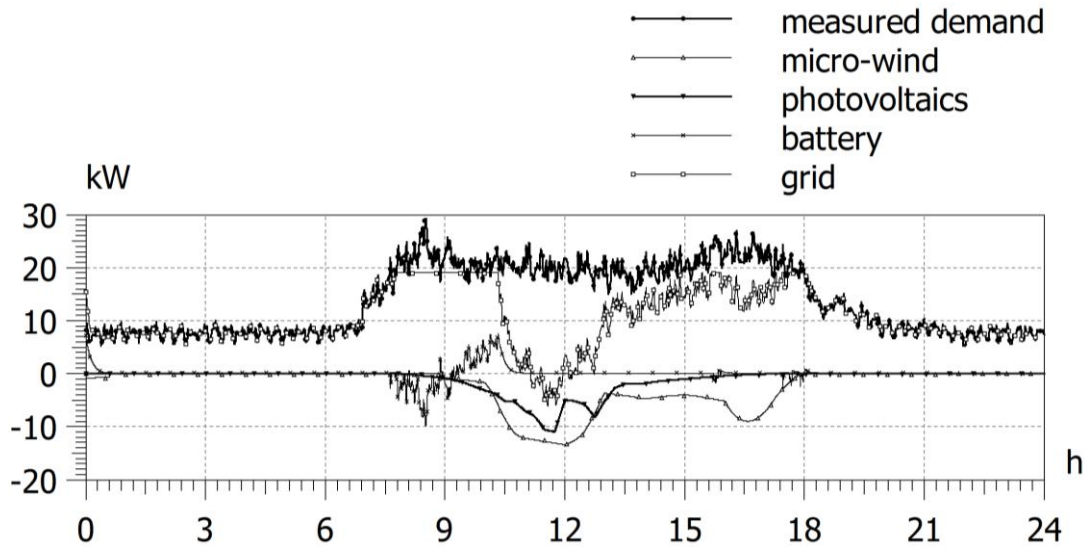

Fig. 9: Results for simulated electrical power

different model-types which are interrelated. Realizing the interrelated behavior of these subsystem-models the connectors transfer all power-relevant data.

## 6 Examples for simulation results

The following example shows the simulated behavior of the thermal and electrical energy flow in an office building in central Germany. The input data is based on measurements from March 2010.

In the simulation run the building is outfitted with five Micro-Wind-Turbines (3m housing, 3.5 kW rated output), photovoltaics rated at 16.5 kWp and a li-ion battery system of 10 kW rated power and 4.32 kWh storage).

Besides the configuration of the energy producing and storing systems in the simulated building the used energy-management-algorithm for system controlling is essential for the calculated power behavior. So in the presented simulation was defined that the building-integrated battery will be discharged above a specific electrical power demand and charged otherwise preferred by local renewable produces energy. The battery application primary use is peak power reduction.

Fig. 9 shows the simulated electrical power. With the above configuration, the peak power drawn from the grid can be significantly reduced by 10 kW. Almost all renewable energy is used locally. The peak at noon could be covered with a marginally bigger battery or used for heating. In case of the selected con-

figuration and parameter-set the cumulative electrical energy demand could be reduced about 20%.

The simulated thermal subsystem contains an oversized 239 m<sup>2</sup> flat plate thermal collector and a 3.5 m<sup>3</sup> hot water storage tank. In the application the solar heat collector charge the heat storage tank. That configuration decouples the heating system in the building from heat sources. In the simulation, all conventional heating is combined as “grid”.

The combined heating system was controlled by the storage temperature at a specific layer as reference value. The heat was then extracted from the tank on demand, observing tank layer and temperature spread.

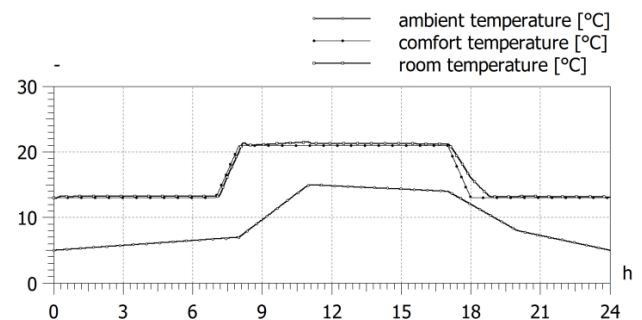

Fig. 10: Simulated temperature characteristics

Fig. 10 shows the initiated and simulated characteristics for ambient, comfort and room temperature. The comfort temperature refers to nominal temperature characteristics in office buildings. Thereby the room temperature has to be reduced in the night in order to save energy.



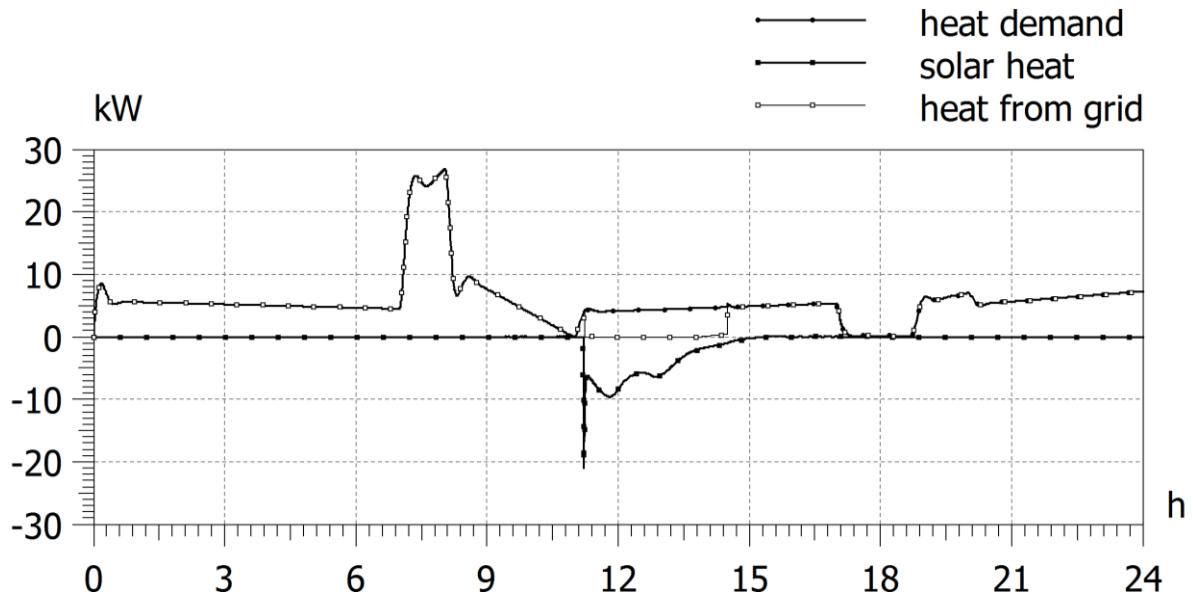

Fig. 11: Results for simulated thermal power

Fig. 11 shows the peak thermal energy demand in the morning (switch to daytime temperature), important for the system layout. A second aspect is shown in the solar heat graph. Only around noon, the collectors get hot enough to charge the storage tank. Additionally the decoupling of solar heat and heating cycle can be seen. The tank size in this case is enough for the day cycle.

In case of such an oversized configuration and parameter-set the cumulative heat demand could be reduced only about 8%. Although it is a sunny winter day, the collectors though oversized, cover only a small part of the heating requirements. Lower temperature heating systems or direct use of the solar heat would be options to find an applicable layout.

Another important result of the simulation addresses the consideration of the influence of the heat produced by the people working in the building. The simulated demand of the building differs about 18% between calculation runs with and without the standardized number of office workers in the building.

Finally the defined requirement on “faster-than-real-time”-simulation could be achieved including sufficient detailed results. The realized factor between the simulation time and the simulated time is 1:1000.

## 7 Conclusion and future developments

As for today, it is possible to simulate the energy flow in a complete combination eVehicle-Building, given a specific configuration of the energy system. Based on the results the configuration can be optimized manually and validated afterwards. Energy-management algorithms can be tested within the simulation. Energy usage and wastage are analyzable and comparable. Including modern charging concepts for eVehicles which are dedicated to a simulated building is also possible.

The future development aims to extend a database with simulation results and input-datasets, including different combinations of buildings, vehicles, locations and usages. This database will also be connected to acknowledged tools for detailed component layout (i.e. PV calculation, heat demand). Furthermore the process of parameter variation and optimization for parameters like energy generation, usage, lifecycle cost and independence shall be automated.

Long term objectives are an independent application and standards for assessment of local renewable energy systems.



Fig. 12: Energy Monitoring (left side); reference building for modular renewable energy management system (right side)

## 8 Research project: “Residence and Mobility”

The described tool is developed within the research project “Residence and Mobility”. The aim is to cover all energy demands of a family and their individual lifestyle with the renewable energy provided around the building they live in. The research project is encouraged with subsidies from the European Union and the Sächsische Aufbaubank (SAB).

Fig. 12 shows the reference building implementing the new technologies including in-house micro-wind-turbines, photovoltaics, CO<sub>2</sub>-heat-pump and 12m<sup>3</sup> heat storage tanks. A user friendly monitoring system shows the workings of the energy system

## References

- [1] H. Winkelmeier: Energiesysteme - Windenergie - 02 - Bauformen und Aerodynamik von Windkraftanlagen. energiewerkstatt<sup>o</sup>, 2005.
- [2] P. Fritzon: Principles of Object-Oriented Modeling and Simulation with Modelica 2.1. Wiley-IEEE Press, 2003.
- [3] R. Unger; T. Schwan; B. Bäker; B. Mikoleit: Optimization tool for local renewable energy usage; ITI Symposium 2010.
- [4] S. Kutter; R. Falsett; B. Bäker; L. Morawietz: Dynamische Modellierung des makroskopischen, thermoelektrischen Verhaltens von Lithium-Ionen-Energiespeichern. Tagung: Elektrik/Elektronik in Hybrid- und Elektrofahrzeugen, Haus der Technik, München, 17./18. November, 2008.
- [5] T. Schwan: Aufbau eines 12V-Lithium-Ionen Batteriedemonstrator, Technische Universität Dresden, IAD Diplomarbeit, Fahrzeugmechatronik, 2009.
- [6] SimulationX-Homepage der ITI GmbH. <http://www.simulationx.com>
- [7] G. Reiner; E. Shafai; R. Wimmer; D. Zogg; H.R. Gabathuler; H. Mayer; H.U. Bruderer: Kurztestmethode für Wärmepumpenanlagen, ETH-Zürich, Sulzer Fritherm AG, 1998.